

Installation and Operation Instructions

Version 3/16

SHEVS Control Centre RWZ 1 b

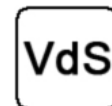

G 513007





0786

EN 12101-10:2005
Class A
0786-CPR-50643 (14)

K + G Tectronic GmbH • In der Krause 48
52249 Eschweiler • Deutschland / Germany
☎ +49 (0) 24 03 / 99 50 - 0 • 📠 +49 (0) 24 03 / 655 30
✉ Info@kg-tectronic.de • 🌐 www.kg-tectronic.de

GRASL Pneumatic-Mechanik GmbH • Europastraße 1
3454 Reidling • Österreich / Austria
☎ +43 (0) 22 76 / 21 200 - 0 • 📠 +43 (0) 22 76 / 21 200 - 99
✉ Office@graslrwa.at • 🌐 www.graslrwa.at

Contents

	Page
1 Concept of Control Centre.....	3
1.1 Options / Accessories.....	3
2 Putting into service / putting out of service	3
2.1 Installation / putting into service	4
2.2 Putting out of service	4
3 Features and Controls	4
3.1 Indicators / control elements of the Control Centre.....	4
3.2 Selectable functions	5
3.3 Indicators / functions of the manual call points	5
3.4 Alarm functions.....	5
3.4.1 Manual call points, automatic fire detectors and Fire Alarm Control Panel.....	6
3.4.2 Repetition of OPEN cycle in case of alarm.....	6
3.5 Ventilation functions	6
3.5.1 Manual ventilation.....	6
3.5.2 Setting the ventilation position 	6
3.5.3 Setting the ventilation time 	6
3.5.4 Ventilation buttons with indication of position OPEN 	7
3.5.5 External Wind and Rain Control (WRC).....	7
3.5.6 Internal Wind and Rain Control (option WRM).....	7
3.6 Repetition of CLOSE cycle.....	7
3.7 Mains failure	7
3.8 Alarm and malfunction forwarding (option PK).....	8
4 Maintenance.....	8
5 Detection of fault / troubleshooting.....	9
5.1 General information	9
5.2 Indications of the service display.....	9
6 Technical data.....	10
6.1 Version	10
6.2 Performance data and characteristics.....	10
7 Terminal and layout diagrams	from A - 1

Please read all information given in these instructions very carefully.

Only skilled personnel are permitted to work on the Control Centre!

Key to pictograms:

 = trouble-free operation

 = alarm

 = malfunction

 = maintenance

 = automatic fire detector

 = button / travel command
CLOSE

 = button / travel command
CLOSE

 = position OPEN

 = wind

 = rain

 = manual call point













 = warning tone / buzzer

 = ventilation position



 = ventilation time

 = Fire Alarm Control Panel
(FACP)

1 Concept of Control Centre

- Smoke and Heat Exhaust Ventilation System (SHEVS) Control Centre for the connection of 24 V- actuators
- VdS approved (to VdS 2581 and VdS 2593)
- Internal power supply designed and certified to DIN EN 12101-10
- Control unit designed and tested to prEN 12101-9
- One SHE group, two signal lines:
 - Line : Automatic fire detectors or Fire Alarm Control Panel (FACP)
 - Line : Manual call points **RT 2** as
 - a) Main alarm point with indicators operation , alarm , malfunction  and button *Reset* . Connection of main alarm point with mini buzzer  (alarm / malfunction) and indication of position  also possible
 - b) Secondary alarm point with indicator alarm 
- Reset the alarm / detector using the button in the main alarm point or in the Control Centre
- Selectable functions:
 - “Auto close” (automatic closure after resetting an alarm)
 - “Malfunction = Alarm” (alarm upon malfunction of a signal line)
 - “Automatic OFF” (automatic travel commands - apart from the alarm - are disabled)
 - “Thermal alarm” (alarm on exceeding an enclosure inside temperature of 70 °C)
- Possibility of connecting ventilation buttons, also with indication of position  .
- Adjustable ventilation position  and ventilation time 
- Possibility of connecting a Wind and Rain Control (WRC), e.g. type **WRS**. Optionally internal Wind and Rain Control
- Internal service display for detailed status information during installation and maintenance
- Plug-in connection terminals (apart from actuator output)
- The use of K + G / Grasl actuators is recommended. When driving third-party actuators, compatibility is to be checked! Also note Section 6 “Technical data”
- Actuator specification: 24 V actuators, travelling time for full stroke at rated load (total travelling time) < 4 min.
- Actuators must be suitable for the repetition of OPEN and / or CLOSE cycle (see 3.4.2 / 3.6)
- Upon direct change of the sense of travel, the actuators are briefly stopped before changing the sense
- Sheet steel enclosure, light grey (RAL 7035)

1.1 Options / Accessories

- **PK**: One potential-free contact (PFC) each for alarm / malfunction forwarding
- **WRM**: Internal Wind- and Rain Control
 - Actuators are automatically closed on response of WRM. Connection of wind sensor **WM** and / or rain sensor **RS** is required (accessory)
 - Direct connection of the sensors on the module. No external WRC required
 - Sensitivity of the sensors is adjustable
 - The closing command remains active as long as a sensor responds, but for at least 6 minutes
 - Indicators for wind  and rain  on the module

 *As there are no corresponding regulations, the optional board WRM is not VdS approved. However its usage does not affect the VdS approval of the Control Centre, since interactions have been checked and excluded during the approval process.*

2 Putting into service / putting out of service

Work at the Control Centre may be performed only by qualified personnel!

Before starting any work it is mandatory to deflect static charge!





We do not assume any guarantee or liability for defects caused by faulty connection.

 *Planning and installation of SHEVS require observation of the following rules, as far as applicable: national building codes / model building code and regulations of the local building and fire safety authorities, VDE regulations (particularly VDE 0100, 0108 and 0833), VdS Guidelines 2098 and 2221, DIN 18232 and EN 12101, DIN 4102, model line systems policy.*

2.1 Installation / putting into service

 *Perform work at the Control Centre only in deenergised condition!*

Actuators may not be driven with external power supply (e.g. external accumulators), if they are already connected to the Control Centre. This can lead to defects in the power output of the Control Centre.

- Fasten the enclosure securely using suitable mounting material. Pass the connection cables through the holes provided.
- Perform the functional setting (see 3.2). Wire the Control Centre according to the terminal diagrams enclosed.
- Turn on line voltage. The indicators and the service display light up briefly. Afterwards the indicator  flickers for about 15 s (calibration process). If the indicator  is permanently lit, there is a malfunction in a signal line (see 5). The service display remains on for 120 s.
- Insert the accumulators in the enclosure, secure them with the fastening plates and connect them as illustrated on the “Line voltage, mounting, accumulators” plan.
- The indicator  lights up, the indicator  extinguishes, the system is ready for operation. If malfunction is still displayed, follow the instructions in Section 5 “Detection of fault / troubleshooting”. If necessary, put the Control Centre out of service once again (see 2.2).
- While putting into service, check all functions and indicators of the Control Centre and its components. The individual functions are described in Section 3 (also simulate malfunctions and check detection, see 5).
- Following putting into service completely close all actuators (if necessary, press button ).

 *After about 24 hours continuous operation without mains failure, the accumulators are sufficiently charged to achieve the full standby time during mains failure.*















2.2 Putting out of service

- Disconnect accumulators from Control Centre (e.g. remove accumulator connection line or fuse F2).
 *Charged accumulators have a shelf-life of about 6 months. For longer storage, they must be recharged.*
- Turn off the line voltage.

3 Features and Controls

Before touching the control elements in the Control Centre it is mandatory to deflect static charge!







3.1 Indicators / control elements of the Control Centre

- **Indicators on the main board:**
 -  (green): **Trouble-free operation**. Extinguishes when a malfunction is detected.
 -  (red): **Alarm**.
 -  (yellow): **Malfunction**.
 -  (blue): **Wind- and Rain Control** is active.
 -  (blue): **Maintenance is due** (flashes) or **Maintenance mode enabled** (is lit).
 -  (red): **Service-Display**, see 5.2.
 -  /  (blue): Travel command active in OPEN or CLOSE direction.
- **Control elements on the main board:**
 - **Button Reset**  (red): Reset the alarm function.
 - **Button Reset**  (yellow): Switch off the warning tone.
 - **Button**  (ventilation position) and **potentiometer**  (ventilation time): see 3.5.2 and 3.5.3.
 - **Button Test** : Activate the alarm test function for maintenance purposes. PFC  (PFC alarm) and buzzer  are not enabled.
 - **Button μ C-Reset**: Only for servicing purposes.

3.2 Selectable functions



- **“Auto close” DIP switch S1-1:**
In position ON, the actuators are automatically closed after resetting a pending alarm. It cannot be ventilated up to 4 minutes during response of the function.
Factory setting: ON (automatic closure is enabled).
- **“Malfunction = Alarm” DIP switch S1-2:**
In the ON position, the alarm function (see 3.4) is activated upon malfunction of a signal line. After eliminating the malfunction, the alarm is reset by pressing the button *Reset*  in a main alarm point or the Control Centre.
Factory setting: OFF (no alarm in case of malfunction).
- **„Automatic OFF“ DIP switch S1-3:**
In position ON, the following automatic functions are disabled: Auto Close, ventilation position and ventilation time, repetition of CLOSE cycle and closing on mains failure or active wind and rain control. Actuators operate during ventilator operation only as long as a button Δ / ∇ is pressed.
Factory setting: OFF (Automatic enabled).
- **“Thermal alarm” DIP switch S1-4:**
In position ON, the alarm function (see 3.4) will be activated when exceeding an enclosure inside temperature of 70 °C.
Factory setting: OFF (no alarm when exceeding 70 °C).
- DIP switches **S1-5** and **S1-6:** The setting must not be changed. Factory setting: OFF



3.3 Indicators / functions of the manual call points

- For activation and reset, see 3.4.
- **Indicators:**
 -  (green, **RT 2-*-BS**): **Trouble-free operation.** Extinguishes when a malfunction is detected.
 -  (red, **RT 2-***): **Alarm.**
 -  (yellow, **RT 2-*-BS**): **Malfunction** (see also 5).
- **Button Reset**  (red, **RT 2-*-BS**): Resetting the alarm function (accessible after opening the door with a key).
- Manual call point with buzzer  for audible alarm and malfunction signalisation (**RT 2-*-BS-AA**):
The buzzer emits a continuous warning tone in case of alarm, and an intermittent warning tone in case of pre-alarm or malfunction.
By pressing the button *Reset*  (yellow) the warning tone is turned off.
- Manual call point with indication of position (**RT 2-*-BS-A**):
The status light  (yellow) lights up when a travel command is executed toward OPEN.
The status light goes out after the closing time for a travel command toward CLOSE (up to 4 minutes).

3.4 Alarm functions

During the execution of an alarm function the ventilation functions are disabled.

Alarm function: Upon detection of an alarm, the actuators are completely opened and indicators  show the alarm condition. Main alarm points with buzzer  (**RT 2 -*- AA**) emit a continuous tone.

Resetting the alarm function: Resetting is done by briefly pressing the button *Reset*  in a main alarm point or the Control Centre. Then the indicators  and the buzzer  will be switched off.

 *Further alarm functions (“Malfunction = Alarm”, “Thermal alarm”, “Auto close”), see 3.2, forwarding alarm / malfunction message, see 3.8.*

If it is closed after reset of an alarm by pressing the button ∇ , it can be manually ventilated again only after up to 4 minutes.

3.4.1 Manual call points, automatic fire detectors and Fire Alarm Control Panel

- **Manual call points:** For manual alarming, break open the glass of the manual call point and press the control button until the indicator  confirms the detection of the alarm.
For maintenance work, the door of the manual call point can be opened with a key.
- **Automatic fire detectors:** The alarming takes place automatically based on smoke and / or heat detection depending on the detector type.
If an automatic fire detector responds again after resetting, repeat the reset step (smoke particles may still be present in the detector).
- **Fire Alarm Control Panel (FACP):** When the FACP generates an alarm, the alarm function is activated.
Resetting of the alarm is done at the FACP.

3.4.2 Repetition of OPEN cycle in case of alarm

- The OPEN command is executed over a period of 30 minutes as follows to ensure opening of the actuator in case of alarm, even at adverse circumstances (e.g. frozen seals):
The actuators travel in the OPEN direction for 2 minutes, briefly in the CLOSE direction and following for 2 minutes in the OPEN direction once again, and so on.

3.5 Ventilation functions



 *The ventilation position, the ventilation time and the wind and rain control are disabled if the function “Automatic OFF” is enabled (see 3.2). Actuators only operate as long as a button Δ / ∇ is pressed.*

 *When performing ventilation functions, do not exceed the duty cycle of the actuator output and the actuators.*

3.5.1 Manual ventilation

- After briefly pressing a ventilation button (Δ / ∇), the actuators travel up to the end position or the set ventilation position X_- (see 3.5.2). Pressing it again stops the actuators. By pressing the button for the reverse sense of travel, the travel direction is reversed after a short stop.
- When pressed longer (> 1 s), the actuators travel as long as the button is pressed. It can also be travelled up to the end position or the set ventilation position (see 3.5.2).

3.5.2 Setting the ventilation position X_-

- Set the travel time toward OPEN and CLOSE to define the desired ventilation position.
Factory setting: 15 s travel time OPEN, 30 s travel time CLOSE.
 *Return to factory settings: Press button X_- for longer than 3 s. The display briefly shows L .
Disable the ventilation position: Press button X_- for longer than 6 s. The display briefly shows $\bar{\alpha}$.*
- Setting the travel times: Briefly press button X_- to enter programming mode (display: L).
 - Open the actuators by briefly pressing the button X_- or a ventilation button Δ . Press the button once more when desired ventilation position is reached.
 - Close the actuators by briefly pressing the button X_- or a ventilation button ∇ . Press the button once more when all actuators are completely closed. The display L extinguishes.
 - The actuators automatically travel to the ventilation position for verification and then close again. *This setting can only be made when the system has no malfunctions and WRC is not active.
Initially, all actuators must be entirely closed.
Programming mode is cancelled automatically after 6 minutes without button activity or manually by double-clicking on the button Reset .*
Use the button X_- to set if a changeover contact is used for ventilation.

3.5.3 Setting the ventilation time A°

- Use a screwdriver on potentiometer A° to set ventilation time to between 5 and 30 minutes. The actuators close automatically at the end of the set time. Turn left to disable ventilation time (= factory setting).

3.5.4 Ventilation buttons with indication of position OPEN ↗

- The indicator ↗ (LT-* - A) lights up when a travel command is executed toward OPEN. The indicator goes out after the closing time for a travel command toward CLOSED (up to 4 minutes).

3.5.5 External Wind and Rain Control (WRC)

- If the Wind and Rain Control responds, the actuators are automatically closed. The ventilation functions are disabled. The indicator ↗ on the main board lights up, until the WRC releases the ventilation functions once again. An alarm has priority.

3.5.6 Internal Wind and Rain Control (option WRM)

- If the internal Wind and Rain Control responds, the actuators are automatically closed. The ventilation functions are disabled. The indicators ↗ and / or ☔ on the module and the indicator ↗ on the main board light up, until the ventilation functions are released once again. An alarm has priority.
- The response thresholds of the sensors can be adjusted with a screwdriver at the potentiometers ↗ and ☔ on the module:
 - Rotating clockwise increases the sensitivity.
 - Rotating counterclockwise reduces the sensitivity.
 Factory setting: highest sensitivity for both sensors.

⚠ *Too low sensitivity setting can cause damage by wind and rain, for which we do not assume any liability.*

- The rain sensor is heated when it rains. This helps the sensor surface to dry faster after rain and to allow ventilation again.
- **“Reduced sensitivity to wind”** DIP Switch **W:S1-1**:
In position ON, sensitivity to gusts of wind is reduced. This setting has no effect on sensitivity to constant wind.
Factory setting: OFF (normal sensitivity).
⚠ *Perform the setting only for correspondingly stable or insensitive designs!*
- **“Continuous heating of rain sensor”** DIP switch **W:S1-2**:
In position ON, the rain sensor is heated continuously at reduced power. For example, this reduces morning dew and incidental activation of the sensor. If the sensor is activated by rain, the heater operates at full power once again up to drying.
Factory setting: OFF (heating is active only in rain).



3.6 Repetition of CLOSE cycle

- If not all actuators are properly closed (e.g. actuator overload cutoff activated by a gust of wind), the repetition of CLOSE cycle can be activated by briefly pressing the ventilation button ∇. The actuators are briefly opened and following the closing command activated once again.
ⓘ *Observe setting of the function “Automatic OFF” (see 3.2).*

3.7 Mains failure

- In case of mains failure, the accumulators cannot be charged, but provide the operating power for the stand-by time. The alarm functions are not affected by the mains failure.
Actuators in ventilation position are closed and pressing the ventilation button ∆ is ignored. The mains failure must be corrected immediately to avoid deep-discharge disconnection, to recharge the accumulators and to ensure the safe operation of the system.
ⓘ *Observe setting of the function “Automatic OFF” (see 3.2).*
- **Deep-discharge disconnection:** in case of critical condition of the accumulators, the entire Control Centre including the indicators is **switched off**. However, a low quiescent current still flows (in addition to the natural self-discharge). Therefore, there is the risk of permanent damage to the accumulators without recharging after a few days already.

3.8 Alarm and malfunction forwarding (option PK)

- **PFC**  (PFC alarm): The contact will be activated upon detection of an alarm. After resetting the alarm, the contact resets to its neutral position.
- **PFC**  (PFC malfunction): The contact is activated when a malfunction is detected (see 5). After eliminating the cause of malfunction, the contact resets to its neutral position.

 *The contacts are not enabled during alarm testing and maintenance mode.*

4 Maintenance





- In the course of maintenance - unless other local regulations apply - check all functions and indicators of the Control Centre and its components at least once a year. This also includes the review of terminal points, connection cables, indicators and fuses, as well as the cleaning of various components, if necessary. Check mounting brackets, etc. for proper fitting. Lubricate actuators and SHE vents (domelights, flap ventilators, louvred ventilators etc.), if necessary.

The individual functions of the Control Centre are described in section 3. Likewise, simulate malfunctions of the signal lines and power supply and check detection; see 5.

- **Display of due maintenance**

If this function has been enabled by the maintenance company, the Control Centre indicates the due maintenance through flashing of indicator  after about 11 months of operating time. For the display of an overdue maintenance, a malfunction signal is generated after about 14 months additionally.

- **Accumulators:**

- Check the accumulators **at least once a year** for proper functioning. They should be replaced following a typical service life of 3, but no more than 4 years in an ambient temperature of 20 °C. The service life falls by 1 year for every 10 °C rise in ambient temperature!
- Checking the accumulators: Press the button **Test**  in the Control Centre and then briefly press the button **Reset** . This switches from mains to accumulator operation during the alarm test (actuators travel a bit slower). Open the actuators completely. If the accumulator voltage falls below 22.5 V, a malfunction is indicated. This indication continues until the button **Reset**  is briefly pressed.
After testing the accumulators, reset the alarm testing (press button **Reset**  briefly) and close all actuators again.
-  *A quick check of the accumulators with less load takes place automatically every 15 minutes.*
- The end user, i.e. the final owner, must return used batteries / accumulators to a distributor or public waste management authority. This obligation to return applies regardless of whether it is a private or commercial end user.
- If the system is put out of service / temporarily shut down, **the accumulators must be unplugged** and the line voltage switched off!
- Charged accumulators that are not connected yet have a shelf-life of about 6 months. For longer storage, they must be recharged.

 **When directly driving actuators**, e.g. with external accumulators during installation or maintenance work, **the actuators must be disconnected from the Control Centre!** Otherwise, this can lead to defects in the power output.

- **Systems with internal wind and rain module (option WRM):**





Following inspections / work should be performed at least once a year:

- Cleaning the rain sensor with a damp cloth, possibly with a mild detergent.
Do not scour the sensor surface!
- Check the wind sensor for smooth-running
- Functional testing of the sensors
- Check whether the SHE units and / or ventilation devices are properly closed



5 Detection of fault / troubleshooting



5.1 General information

Occurrence of a malfunction is indicated by flashing of the indicator  in the main alarm points and in the Control Centre. With the help of the service display, the cause can be isolated (see 5.2).



































- The following are detected as **malfunctions**:
 - Accumulator or mains failure, accumulator polarity reversed
 - Failure of the fuses F1 to F3
 - Wire-break or short-circuit of signal lines
 - Wire-break or short-circuit of the actuator supply line (unbranched common line)
 - Maintenance is overdue
- Notify maintenance company in case of malfunction.
- **Spare material:** In the Control Centre, there is a bag of spare fuses and resistors.
- **Calibration of the signal lines:** After clearing a persistent malfunction, the signal lines are calibrated automatically. During this the status light  flickers for approximately 15 s. If status light  is permanently lit, there is a malfunction in a signal line.
Short malfunctions (< 10 minutes) do not start the calibration process (e.g. maintenance work, such as a brief removal of a detector to check the malfunction indication).
- **Memory of the service display:** If there is no pending alarm or malfunction, the memory content can be displayed for 1 s by briefly pressing the button *Reset*  (alarm memory) or *Reset*  (malfunction memory).
- After troubleshooting, the cause of malfunction will not be shown at the service display any longer. An exception is the malfunction code [L] “accumulator test failed” (see also 4 (Accumulators) and 5.2). This code has to be reset after troubleshooting by pressing the button *Reset* .

5.2 Indications of the service display

- With the help of the internal service display, operating conditions can be accurately displayed. In normal condition, the service display is blank and the indicator  of the Control Centre is lit.
- For alarm / malfunction, the display is switched on automatically, but switched off after 10 s during mains failure. In this case, it may be switched on again for 10 s by pressing the button *Reset*  for 4 s.

 *If there is no alarm / malfunction, the indication of the accumulator charging method can be switched on for 120 s by pressing the button *Reset*  for 4 s: [u.] = U-Charging, [v.] = I-Charging, [.] = no charging.*

Operating conditions of the Control Centre:

Code	Description	Code	Description
	Mains failure or fuse F1 blown		Adjustment ventilation position
	Wire-break of accumulators or fuse F2 blown		Ventilation position deactivated
	Actuator output: fuse F3 blown		Changeover contact for ventilation detected
	Actuator output: wire-break / short circuit		Alarm through internal thermal sensor
	Line  : alarm		Accumulator test active
	Line  : wire-break		Accumulator test failed
	Line  : short circuit		Accumulator polarity reversed
	Line  : undefined	-	Memory alarm / malfunction empty
	Line  : alarm		Button <i>Reset</i>  : short circuit
	Line  : wire-break		Button <i>Reset</i>  : short circuit
	Line  : short circuit		Alarm test active
	Line  : undefined		Maintenance is due
	“Malfunction = Alarm” active		Microcontroller fault

6 Technical data

6.1 Version

Type	RWZ 1-4b
Product code	8100 1204 0000
Output current	4 A (24 V $\overline{=}$ / 192 W)
Current input	0,7 A / 230 V \sim
Lead-gel accumulators, VdS approved	2 x 2 Ah / 12 V
I / U charging	0,2 A (28,8 V) / 27,4 V
Dimensions in mm (W x H x D)	330 x 330 x 110





The Control Centre complies with the requirements of the 2006/95/EC and 2004/108/EC Directives (emission: EN 61000-6-3 and EN 55022, immunity: EN 61000-6-2 and EN 50130-4).

6.2 Performance data and characteristics

General

Line voltage supply	230 V \sim / 50 - 60 Hz
Internal voltage supply / standby time	24 V $\overline{=}$ / 72 h (mains failure)
Cable entry	from above, below or behind
Environmental class 1 / III (EN 12101-10 / VdS 2581)	-5 °C ... +40 °C
Relative humidity	20 % ... 80 %, non-condensing
Enclosure protection rating	IP30
Mounting dimensions, see plan "Line voltage, mounting and accumulators".	
Not suitable for use outdoors. Protect from direct sunlight, humidity and excessive formation of dust!	
Preferably, the installation should be carried out in dry, heated rooms.	

Signal lines

Line monitoring	wire-break, short-circuit
Line  : Automatic fire detectors: Smoke detector / heat detector (RM 2 / TM 2 or RM 3 / TM 3)	20 pieces, of which max. 10 heat detectors ¹
or	
Fire Alarm Control Panel - Terminating resistor - Alarm resistor	normally open contact 10 k Ω (\pm 10 %, 1/4 W) 1 k Ω ... 1.5 k Ω (\pm 10 %, 1/2 W)
Line  , manual call points: - Secondary alarm point (RT 2-*) - Main alarm point (RT 2-*-BS) - Main alarm point (RT 2-*-BS-A , with indication ) - Main alarm point (RT 2-*-BS-AA , with buzzer )	in total 10 pieces, of which max. 3 pieces with buzzer

In- / Outputs

Ventilation button (LT)	unlimited
Ventilation button with indication of position  (LT-A)	10 pieces
Wind and Rain Control (type WRS)	normally closed contact ²
External malfunction	normally closed contact

¹ Heat detectors: **TM 2-D** (65-55000-122), **TM 2-M** (65-55000-137), **TM 3-D** (FD-851RE), **TM 3-M** (FD-851HTE), **RM 3-OT** (SD-851-TE),
Optical detectors: **RM 2-O** (65-55000-317), **RM 3-O** (SD-851-E)

² In the WRC, use a separate contact for each connected Control Centre

Actuator output

Rated voltage	24 V $\overline{=}$ (+6 V / -4 V)
Mode of operation / duty cycle	S3 30 %
Maximum cable cross-section of the supply line	2 x 10 mm ² (rigid)
Allowed voltage drop between Control Centre and actuator	1 V at full load
Line monitoring (unbranched common line)	wire-break, short-circuit





Allowed cable length with simple and moderately branched arrangement of the actuators

Current Cross-section	1.0 A	2.0 A	3.0 A	4.0 A
2 x 1.5 mm ²	44 m	22 m	15 m	11 m
2 x 2.5 mm ²	73 m	36 m	24 m	18 m
2 x 4.0 mm ²	116 m	58 m	39 m	29 m
2 x 6.0 mm ²	174 m	87 m	58 m	44 m
2 x 10.0 mm ²	290 m	145 m	97 m	73 m

Fuses

Primary mains (miniature fuse 5 x 20 mm)	F1: T 2 A
Accumulators (flat fuse 19 mm)	F2: 10 A
Actuators (flat fuse 19 mm)	F3: 10 A

Alarm and malfunction forwarding (option PK)

Contact load rating PFC-  , PFC-  (changeover contacts)	5 A / 30 V $\overline{=}$ / 230 V \sim
Fuses PFC-  , PFC-  (miniature fuses 5 x 20 mm)	P:F1, P:F2: F 5 A

Internal Wind and Rain Control (option WRM)

Wind sensor WM , heated rain sensor RS	1 piece each
Adjustment range of sensitivity to wind	approx. 5 - 15 m/s (20 - 60 km/h, approx. wind force 3 - 7)
Adjustment range of sensitivity to rain	light - stronger rain

SHEVS Control Centre RWZ 1b

System diagram (please consider local conditions / components)

Example of connection on page A-2, detailed examples on following pages.

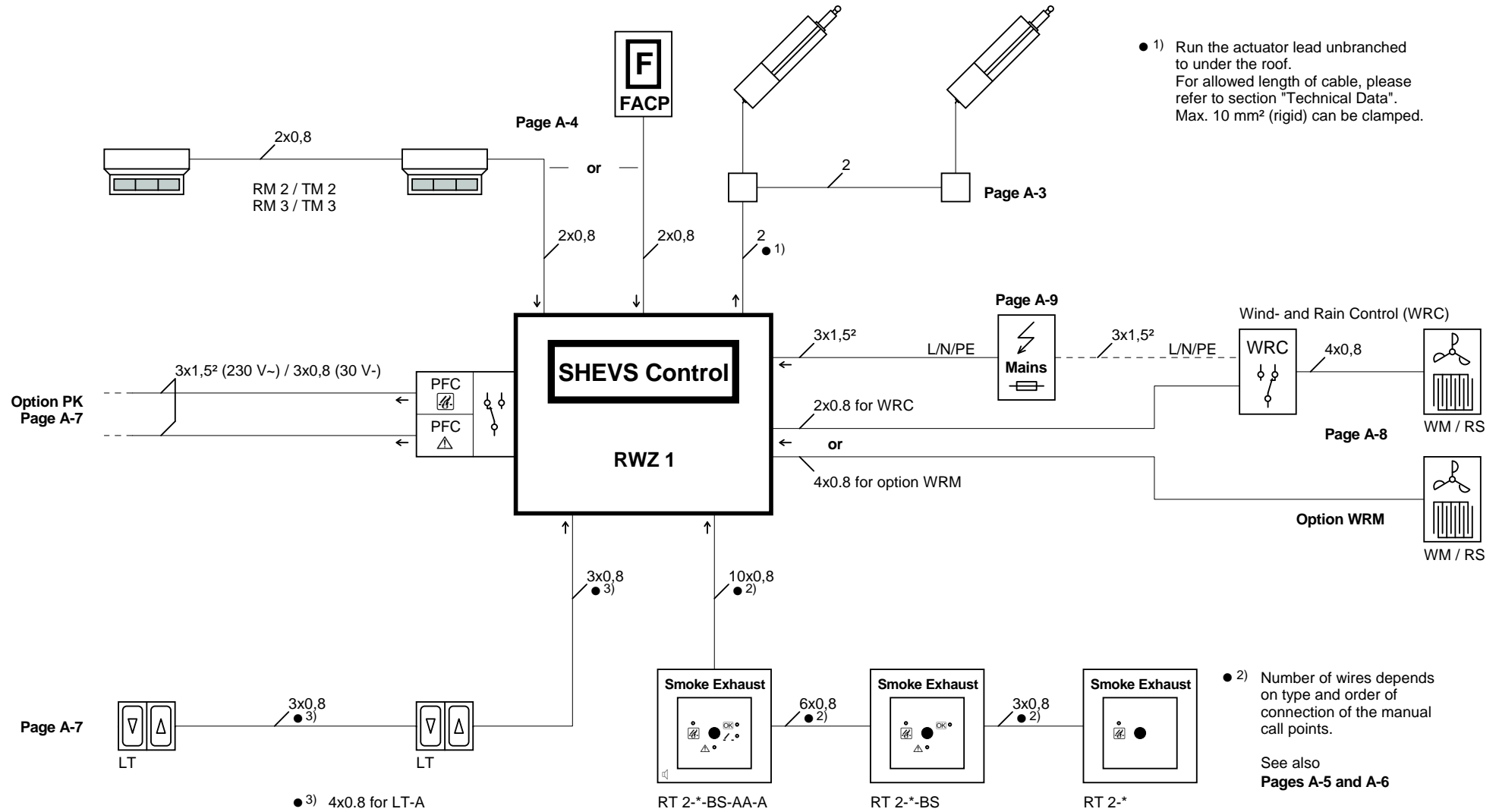

General: length of cable max. 400 m, if not specified otherwise.

Cable types (examples):
 Signal lines: J-Y(St)Y 2x2x0,8 - 5x2x0,8
 Mains: NYM-J 3x1,5 mm²
 PFC: NYM-J 4x1,5 mm² / NYM-O 3x1,5 mm²

RWZ1bA21.sch

RWZ1bA22.sch

Ver. 2/16 Mo 11 Feb. 2016

A - 1 / 9

SHEVS Control Centre RWZ 1b

Example of connection

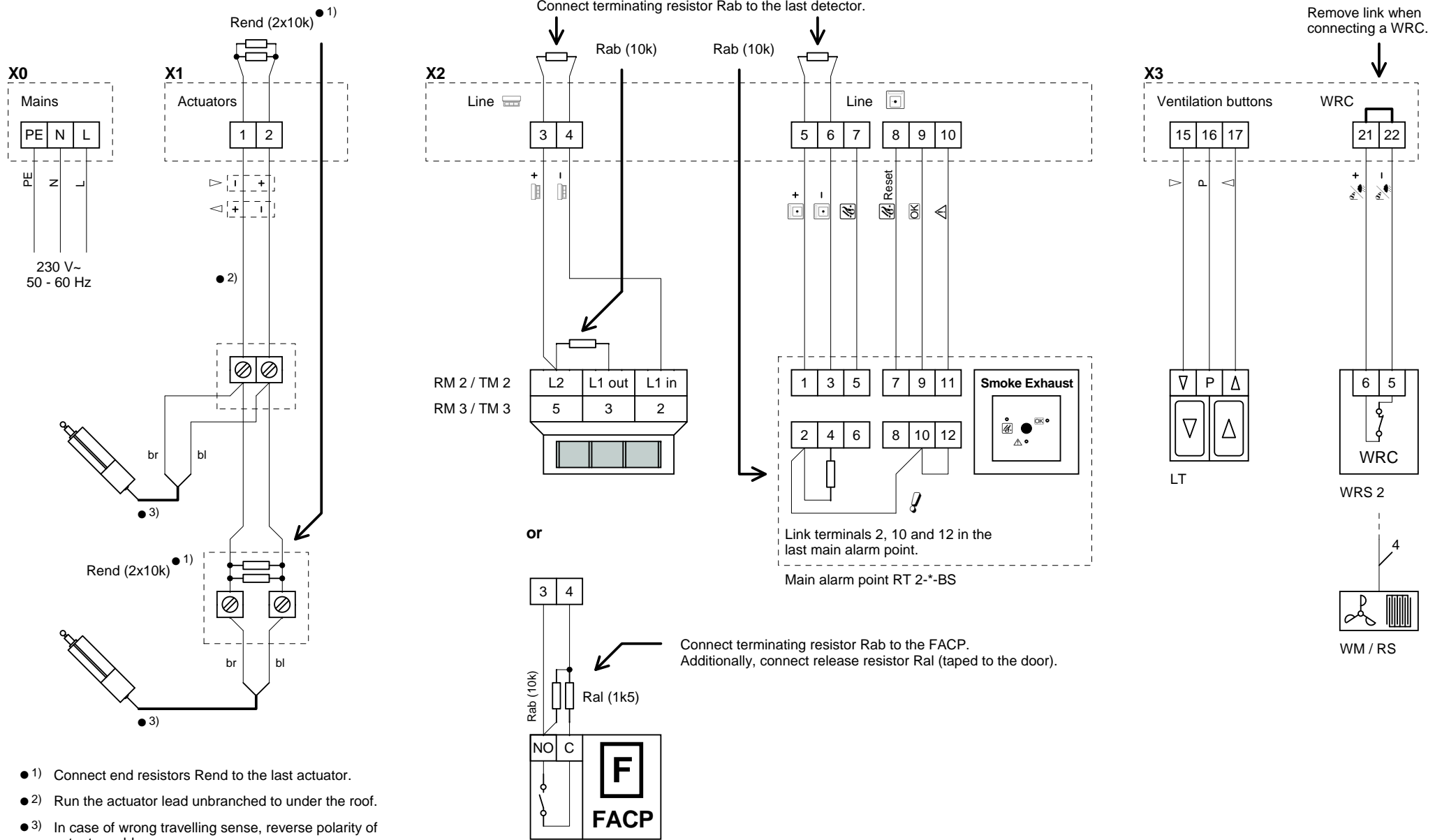

- 1) Connect end resistors Rend to the last actuator.
- 2) Run the actuator lead unbranched to under the roof.
- 3) In case of wrong travelling sense, reverse polarity of actuator cable.

Colour code for resistors: 10k = brown/black/black/red 1k5 = brown/green/black/brown

SHEVS Control Centre RWZ 1b

24 V- actuators

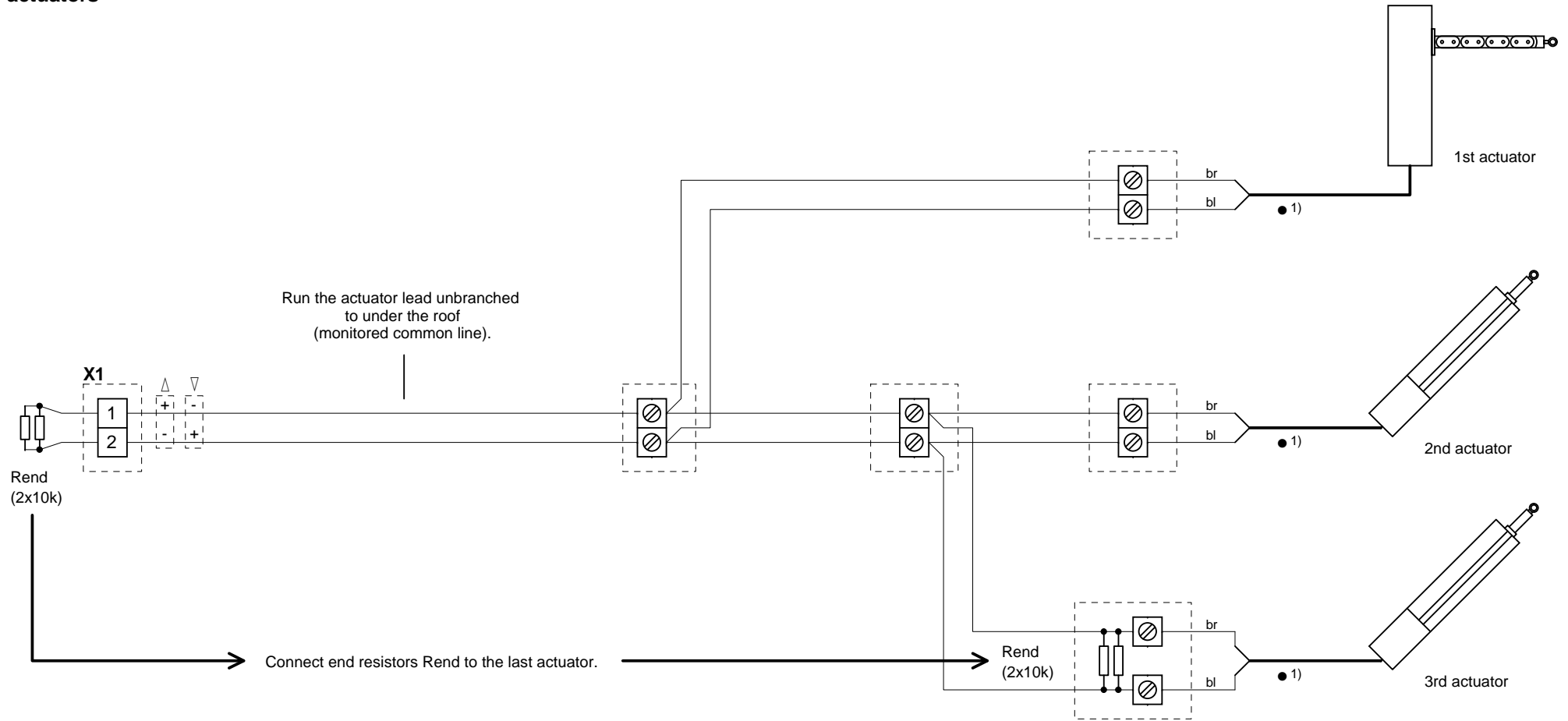

⚠ When directly driving actuators, e.g. with external accumulators during installation or maintenance work, the actuators must be disconnected from the Control Centre!

● 1) In case of wrong travelling sense, reverse polarity of actuator cable.

Colour code for resistors: 10k = brown/black/black/red

SHEVS Control Centre RWZ 1b

Automatic fire detectors or Fire Alarm Control Panel (FACP)

Automatic fire detectors **RM 2 / TM 2** (terminals L1 in, L1 out and L2) or **RM 3 / TM 3** (terminals 2, 3 and 5)

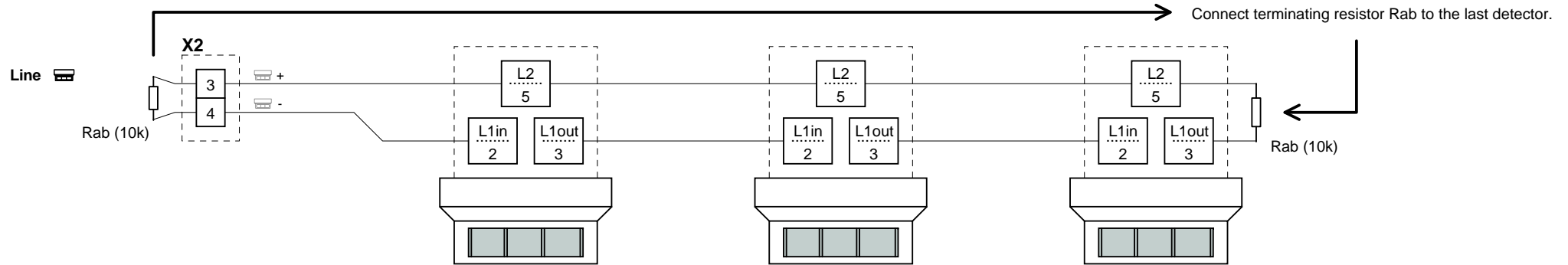

or

Fire Alarm Control Panel (FACP)

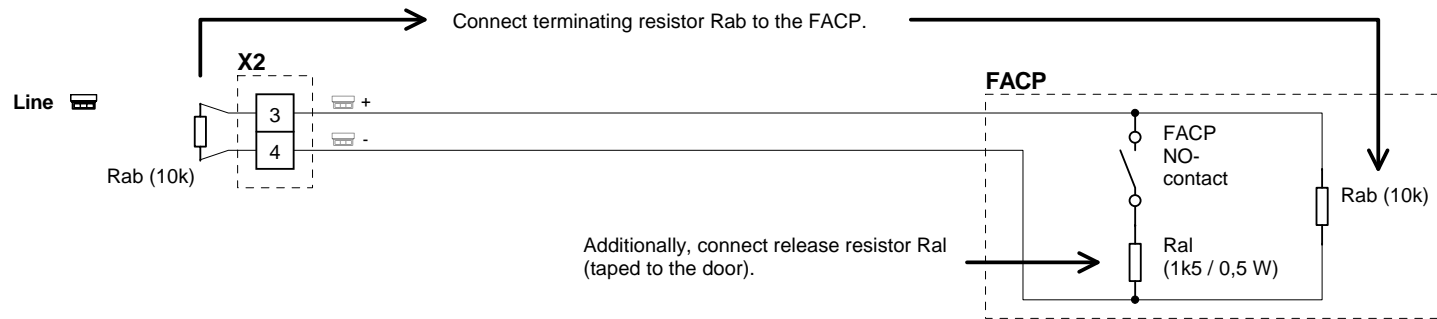

SHEVS Control Centre RWZ 1b

Manual call points

1st example: Main alarm point last (secondary alarm point last: see page A-6)

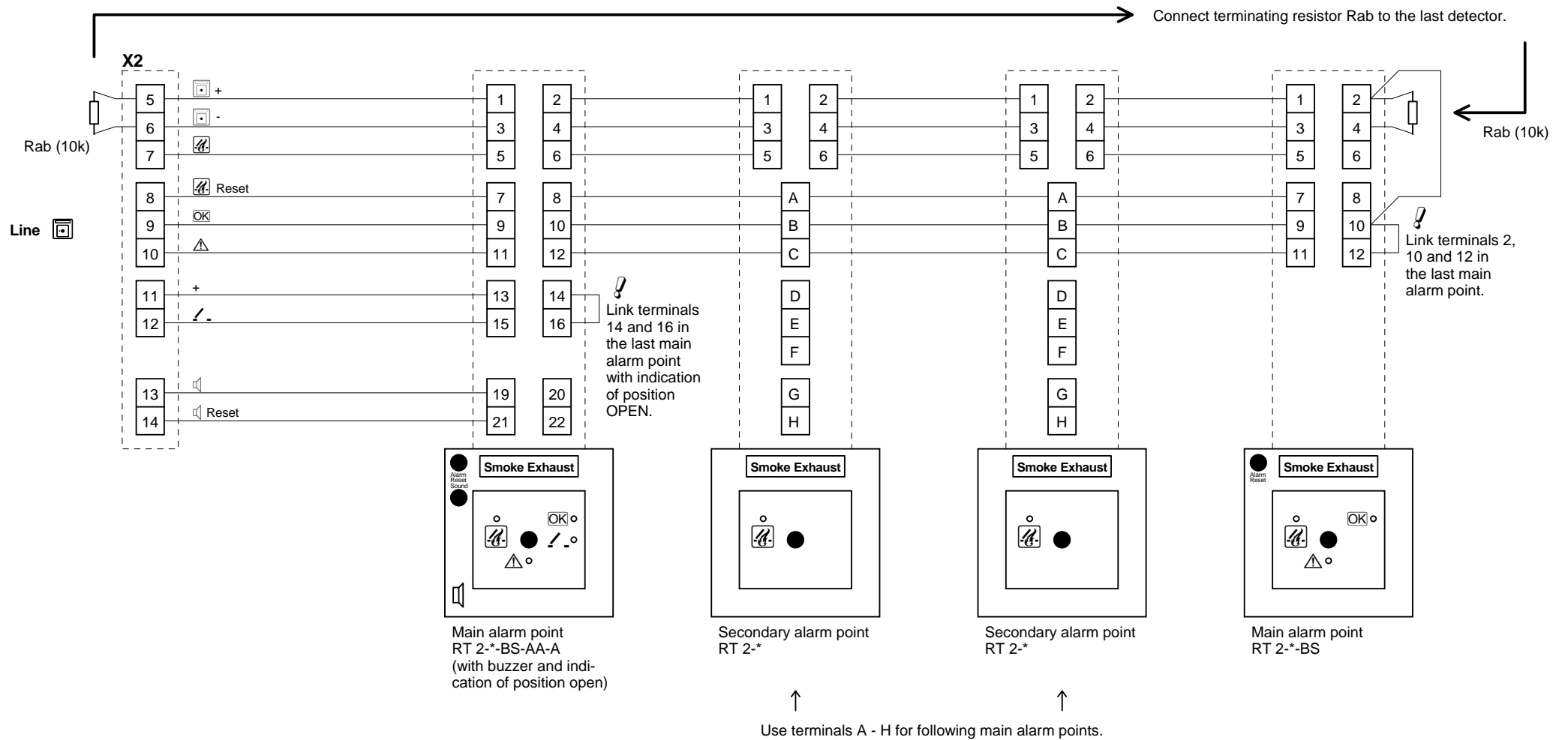

SHEVS Control Centre RWZ 1b

Manual call points

2nd example: Secondary alarm point last (main alarm point last: see page A-5)

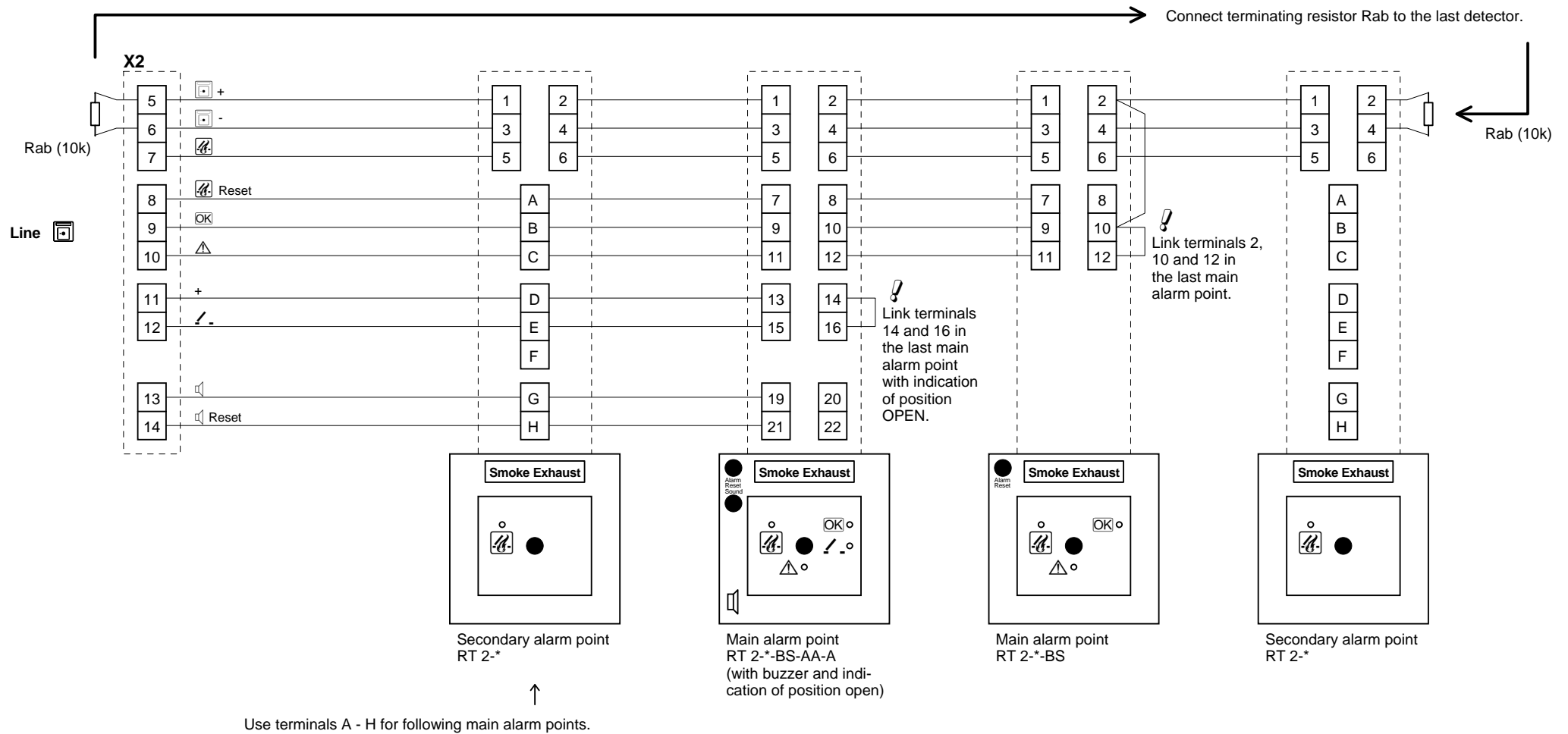

SHEVS Control Centre RWZ 1b

Ventilation buttons, potential-free contacts (option PK)

Ventilation buttons

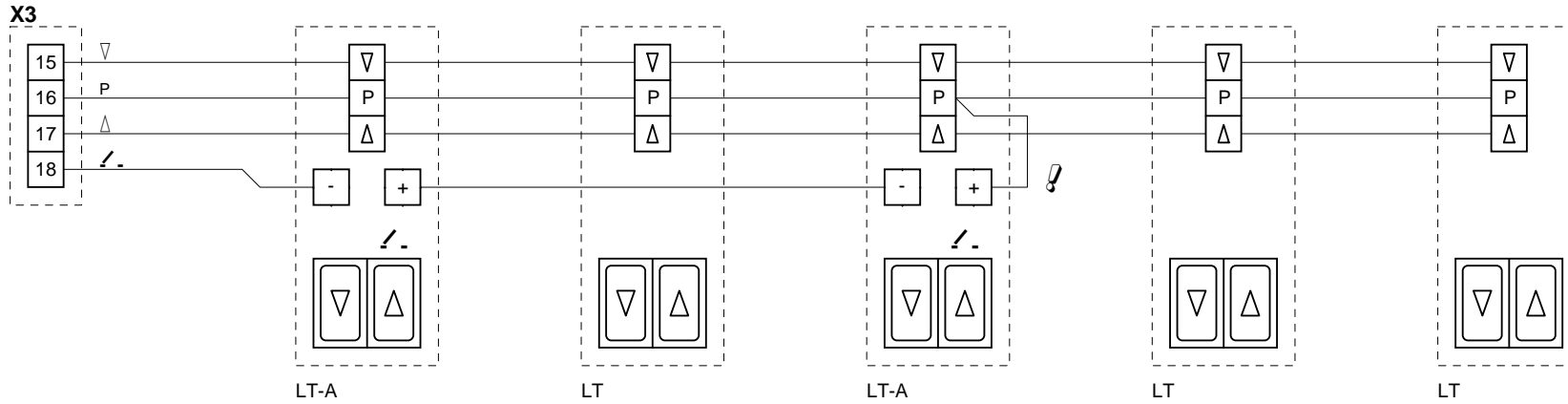

⚠ Link terminals + and P in the last ventilation button with indication of position OPEN.

Potential-free contacts (option PK)

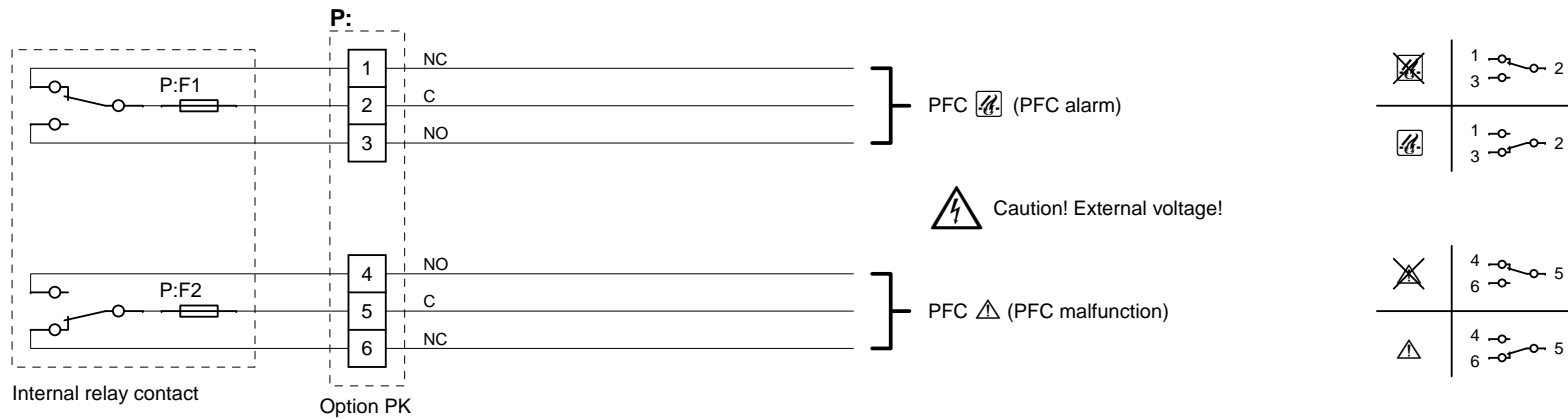

SHEVS Control Centre RWZ 1b

Wind and Rain Control (external / internal)

External Wind and Rain Control

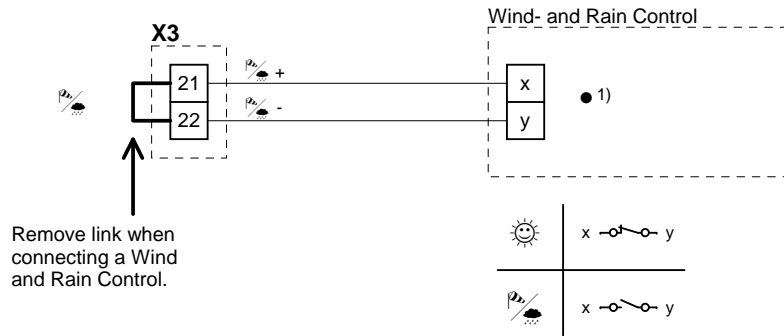

• 1)

WRS 2	x	y
Output contact 1	5	6
Output contact 2	8	9
Output contact 3	11	12
Output contact 4	14	15

Use a separate contact for each connected Control Centre / Control!

Internal Wind and Rain Control (option WRM)

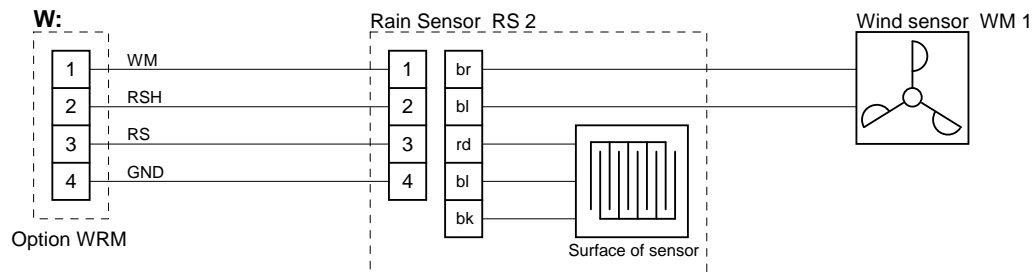

Connection of wind sensor without rain sensor

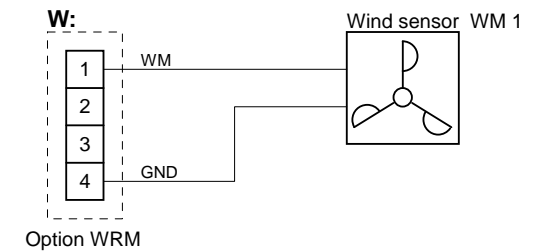

SHEVS Control Centre RWZ 1b

Line voltage, mounting, accumulators

Line voltage:

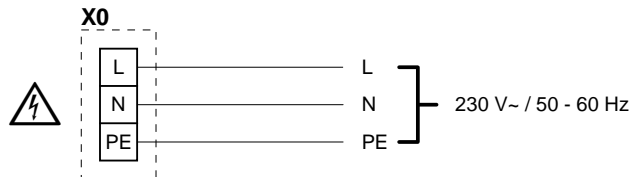

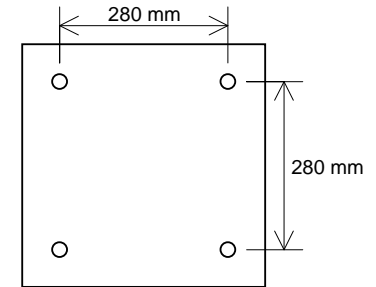

Mounting:

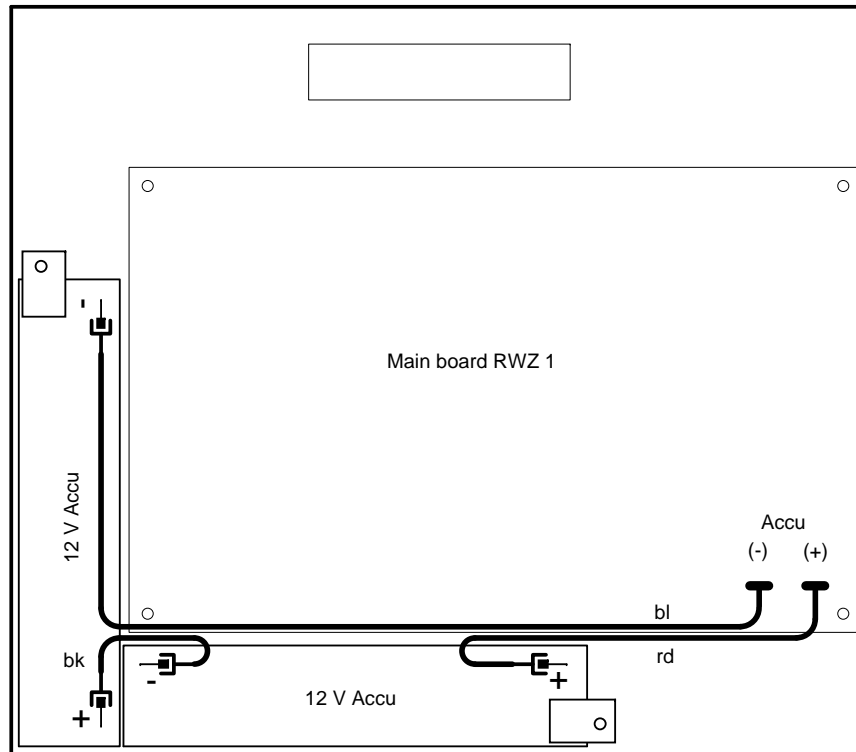

Accumulators:

Insert the accumulators in the enclosure, secure them with the fastening plates and connect them as illustrated.



 When putting into / out of service, observe the operating instructions!
Be sure to disconnect the accumulators if mains voltage supply is cut out for a longer time.

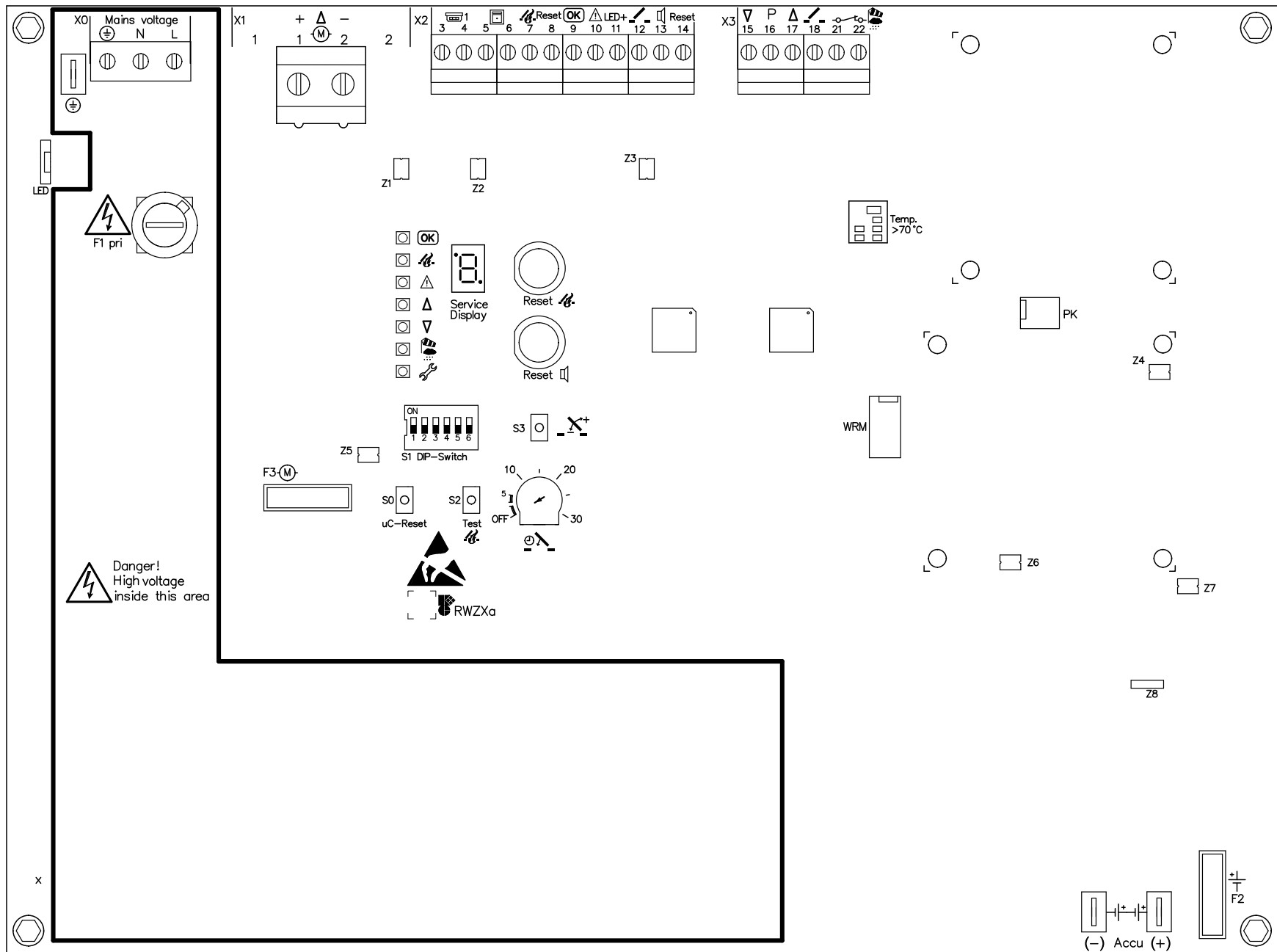

Fuses

- F1: T 2 A Primary mains
- F2: 10 A Accumulators
- F3: 10 A Actuators

DIP-Switch

- S1: 1: Auto close
- 2: Malfunction=Alarm
- 3: Automatic OFF
- 4: Thermal alarm
- 5: The setting must not be changed
- 6: The setting must not be changed

SHEVS Control Centre RWZ 1b

Layout diagram 1

RWZ1bA21.pcb

Ver. 2/16 Mo 11 Feb. 2016

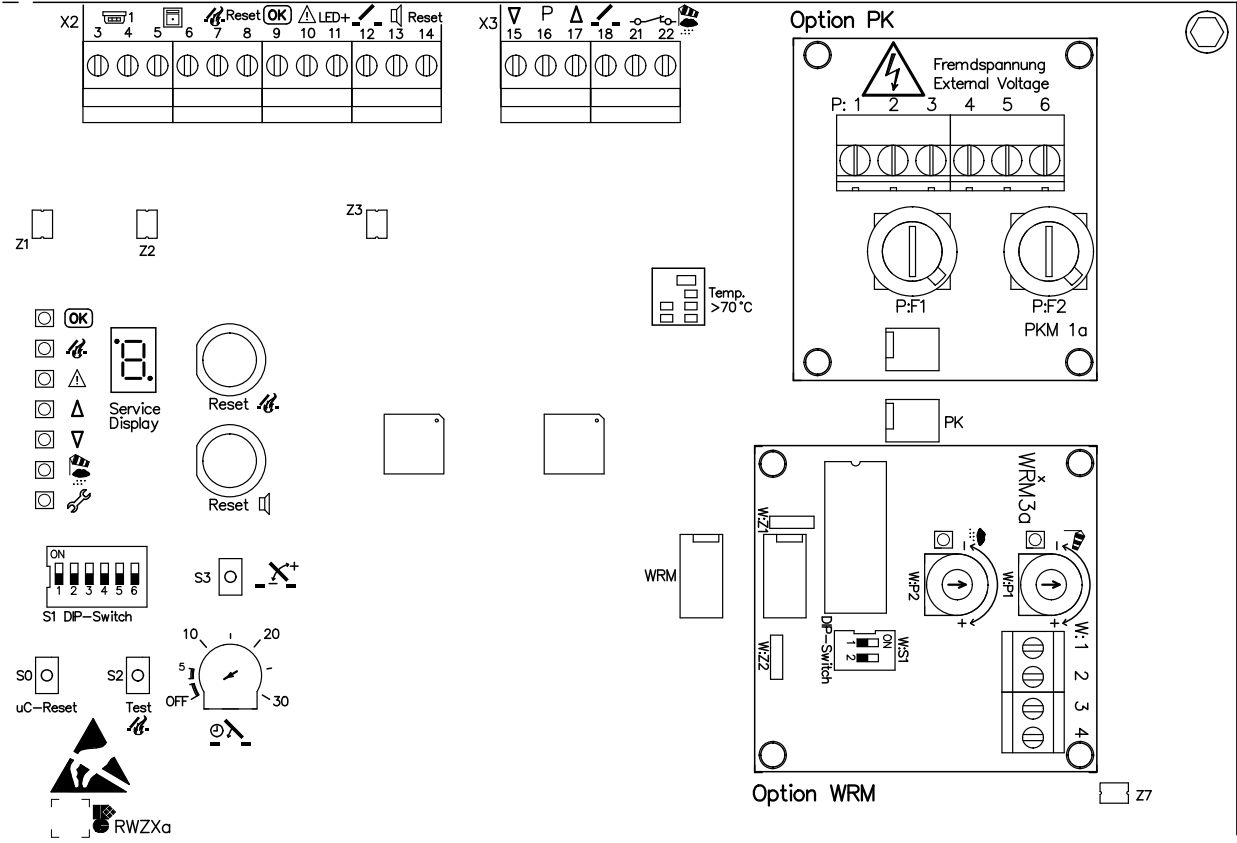

Option PK

P:F1: F 5 A, PFC-~~⚡~~
P:F2: F 5 A, PFC-~~⚡~~

Option WRM

DIP switch W:S1:
1: Reduced sensitivity to wind
2: Continuous heating of rain sensor

SHEVS Control Centre RWZ 1b	
Layout diagram 2 / options	
RWZ1bA12.pcb	Ver. 1/14 Mo 17 Mar. 2014